

ADC12010

12-Bit, 10 MSPS, 160 mW A/D Converter with Internal Sample-and-Hold

General Description

The ADC12010 is a monolithic CMOS analog-to-digital converter capable of converting analog input signals into 12-bit digital words at 10 Megasamples per second (MSPS), minimum. This converter uses a differential, pipeline architecture with digital error correction and an on-chip sample-and-hold circuit to minimize die size and power consumption while providing excellent dynamic performance. Operating on a single 5V power supply, this device consumes just 160 mW at 10 MSPS, including the reference current. The Power Down feature reduces power consumption to 25 mW.

The differential inputs provide a full scale input swing equal to $2V_{REF}$ with the possibility of a single-ended input. Full use of the differential input is recommended for optimum performance. For ease of use, the buffered, high impedance, single-ended reference input is converted on-chip to a differential reference for use by the processing circuitry. Output data format is 12-bit offset binary.

This device is available in the 32-lead LQFP package and will operate over the industrial temperature range of -40°C to $+85^{\circ}\text{C}$.

Features

- Internal sample-and-hold
- Outputs 2.4V to 5V compatible
- Pin compatible with ADC12020, ADC12040, ADC12L063 and ADC12L066
- On-chip reference buffer
- Power down mode

Key Specifications

- | | |
|-------------------------------|---------------------|
| ■ Resolution | 12 Bits |
| ■ Conversion Rate | 10 MSPS (min) |
| ■ DNL | ± 0.3 LSB (typ) |
| ■ ENOB ($f_{IN} = 10.1$ MHz) | 11.3 bits (typ) |
| ■ Supply Voltage | $+5V \pm 5\%$ |
| ■ Power Consumption, 10 MHz | 160 mW (typ) |

Applications

- Image Processing Front End
- Instrumentation
- PC-Based Data Acquisition
- Fax Machines
- Wireless Local Loops/Cable Modems
- Waveform Digitizers
- DSP Front Ends

Connection Diagram

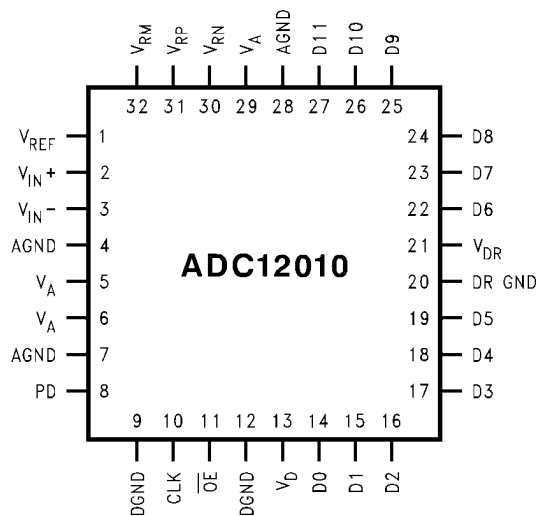

20051601

Ordering Information

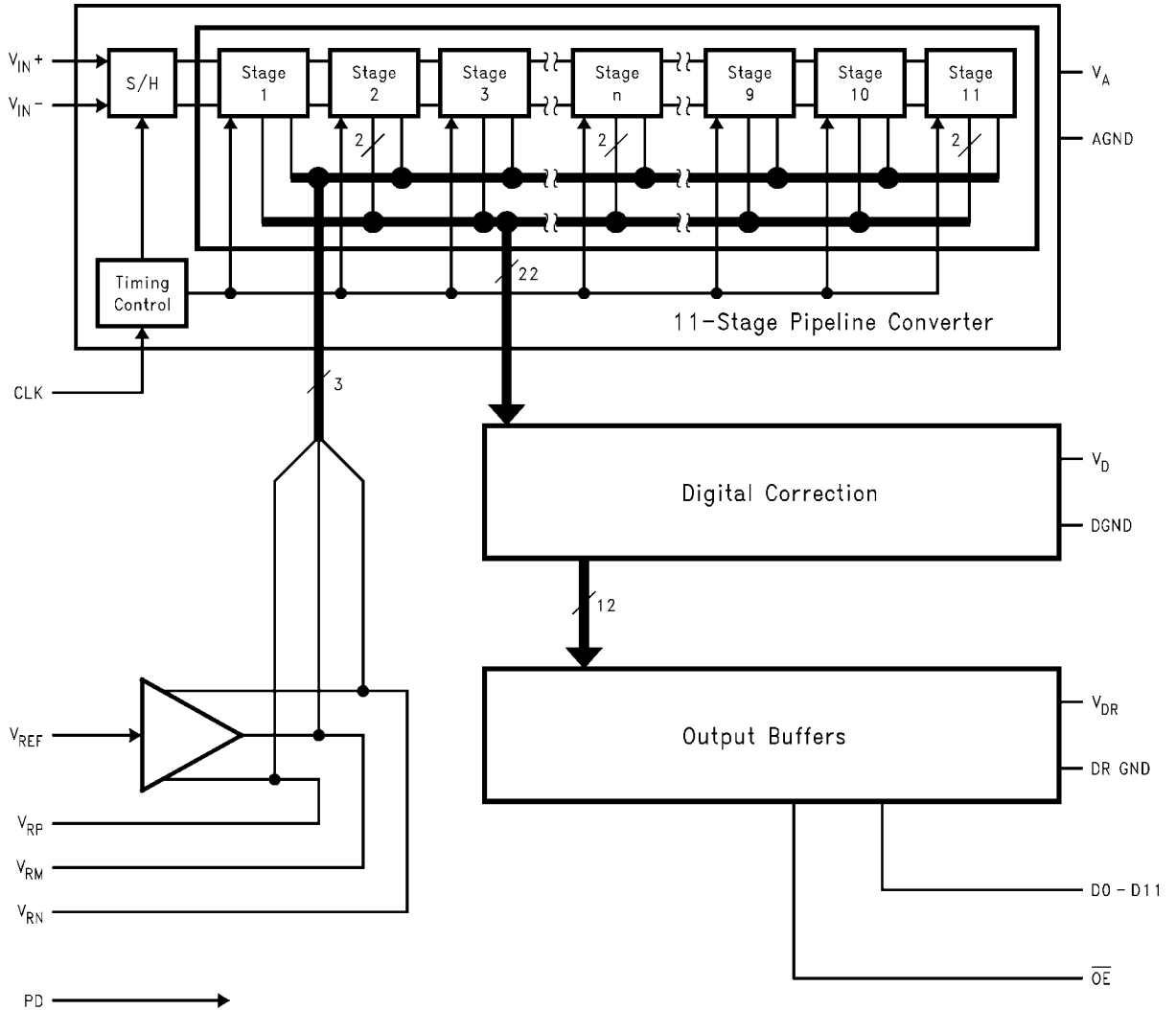

Industrial ($-40^{\circ}\text{C} \leq T_A \leq +85^{\circ}\text{C}$)	Package
ADC12010CIVY	32 Pin LQFP
ADC12010CIVYX	32 Pin LQFP Tape and Reel
ADC12040EVAL	40 Msps Evaluation Board

Block Diagram

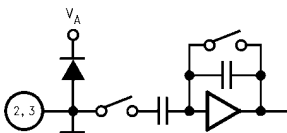

20051602

Pin Descriptions and Equivalent Circuits

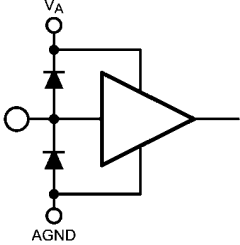
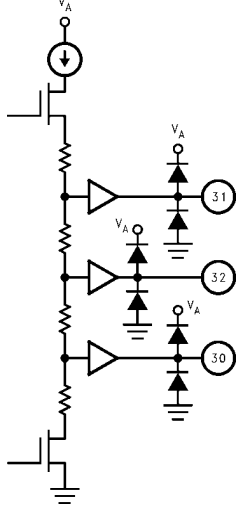
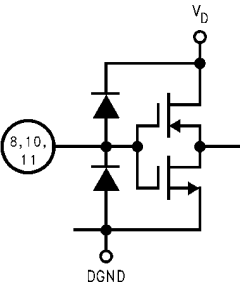
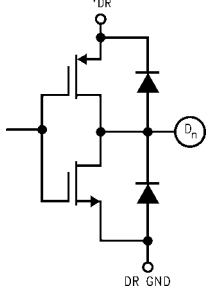
Pin No.	Symbol	Equivalent Circuit	Description
ANALOG I/O			
2	V_{IN+}		Non-Inverting analog signal Input. With a 2.0V reference voltage, the ground-referenced input signal level is 2.0 V_{P-P} centered on V_{CM} .
3	V_{IN-}		Inverting analog signal Input. With a 2.0V reference voltage the ground-referenced input signal level is 2.0 V_{P-P} centered on V_{CM} . This pin may be connected to V_{CM} for single-ended operation, but a differential input signal is required for best performance.
1	V_{REF}		Reference input. This pin should be bypassed to AGND with a 0.1 μF monolithic capacitor. V_{REF} is 2.0V nominal and should be between 1.0V to 2.4V.
31	V_{RP}		These pins are high impedance reference bypass pins. Connect a 0.1 μF capacitor from each of these pins to AGND. DO NOT LOAD these pins.
32	V_{RM}		
30	V_{RN}		
DIGITAL I/O			
10	CLK		Digital clock input. The range of frequencies for this input is 100 kHz to 15 MHz (typical) with guaranteed performance at 10 MHz. The input is sampled on the rising edge of this input.
11	\overline{OE}		\overline{OE} is the output enable pin that, when low, enables the TRI-STATE® data output pins. When this pin is high, the outputs are in a high impedance state.
8	PD		PD is the Power Down input pin. When high, this input puts the converter into the power down mode. When this pin is low, the converter is in the active mode.
14–19, 22–27	D0–D11		Digital data output pins that make up the 12-bit conversion results. D0 is the LSB, while D11 is the MSB of the offset binary output word. Output levels are TTL/CMOS compatible.

Pin No.	Symbol	Equivalent Circuit	Description
ANALOG POWER			
5, 6, 29	V_A		Positive analog supply pins. These pins should be connected to a quiet +5V voltage source and be bypassed to AGND with 0.1 μ F monolithic capacitors located within 1 cm of these power pins, and with a 10 μ F capacitor.
4, 7, 28	AGND		The ground return for the analog supply.
DIGITAL POWER			
13	V_D		Positive digital supply pin. This pin should be connected to the same quiet +5V source as is V_A and bypassed to DGND with a 0.1 μ F monolithic capacitor in parallel with a 10 μ F capacitor, both located within 1 cm of the power pin.
9, 12	DGND		The ground return for the digital supply.
21	V_{DR}		Positive digital supply pin for the ADC12010's output drivers. This pin should be connected to a voltage source of +2.35V to +5V and be bypassed to DR GND with a 0.1 μ F monolithic capacitor. If the supply for this pin is different from the supply used for V_A and V_D , it should also be bypassed with a 10 μ F tantalum capacitor. V_{DR} should never exceed the voltage on V_D . All bypass capacitors should be located within 1 cm of the supply pin.
20	DR GND		The ground return for the digital supply for the ADC12010's output drivers. This pin should be connected to the system digital ground, but not be connected in close proximity to the ADC12010's DGND or AGND pins. See Section 5 (Layout and Grounding) for more details.

Absolute Maximum Ratings (Notes 1, 2)

If Military/Aerospace specified devices are required, please contact the National Semiconductor Sales Office/Distributors for availability and specifications.

V_A, V_D	6.5V
V_{DR}	$\leq V_D + 0.3V$
$ V_A - V_D $	$\leq 100\text{ mV}$
Voltage on Any Input or Output Pin	-0.3V to (V_A or V_D + 0.3V)
Input Current at Any Pin (Note 3)	$\pm 25\text{ mA}$
Package Input Current (Note 3)	$\pm 50\text{ mA}$
Package Dissipation at $T_A = 25^\circ\text{C}$	See (Note 4)
ESD Susceptibility	
Human Body Model (Note 5)	2500V
Machine Model (Note 5)	250V
Soldering Temperature, Infrared, 10 sec. (Note 6)	235°C
Storage Temperature	-65°C to +150°C

Operating Ratings (Notes 1, 2)

Operating Temperature	$-40^\circ\text{C} \leq T_A \leq +85^\circ\text{C}$
Supply Voltage (V_A, V_D)	+4.75V to +5.25V
Output Driver Supply (V_{DR})	+2.35V to V_D
V_{REF} Input	1.0V to 2.4V
CLK, PD, \overline{OE}	-0.05V to ($V_D + 0.05V$)
V_{IN} Input	-0V to ($V_A - 0.5V$)
V_{CM}	1.0V to 4.0V
IAGND-DGNDI	$\leq 100\text{ mA}$

Package Thermal Resistance

Package	θ_{JA}
32-Lead LQFP	79°C / W

Converter Electrical Characteristics

Unless otherwise specified, the following specifications apply for AGND = DGND = DR GND = 0V, $V_A = V_D = +5V$, $V_{DR} = +3.0V$, PD = 0V, $V_{REF} = +2.0V$, $f_{CLK} = 10\text{ MHz}$, $t_r = t_f = 3\text{ ns}$, $C_L = 25\text{ pF/pin}$. **Boldface limits apply for $T_A = T_J = T_{MIN}$ to T_{MAX}** : all other limits $T_A = T_J = 25^\circ\text{C}$ (Notes 7, 8, 9)

Symbol	Parameter	Conditions	Typical (Note 10)	Limits (Note 10)	Units (Limits)
STATIC CONVERTER CHARACTERISTICS					
	Resolution with No Missing Codes			12	Bits (min)
INL	Integral Non Linearity (Note 11)		± 0.5	± 1.5	LSB (max)
DNL	Differential Non Linearity		± 0.3	± 0.9	LSB (max)
GE	Gain Error		± 0.2	2.9	%FS (max)
	Offset Error ($V_{IN} = V_{IN-}$)		-0.1	1.75	%FS (max)
	Under Range Output Code		0	0	
	Over Range Output Code		4095	4095	
DYNAMIC CONVERTER CHARACTERISTICS					
FPBW	Full Power Bandwidth	0 dBFS Input, Output at -3 dB	100		MHz
SNR	Signal-to-Noise Ratio	$f_{IN} = 1\text{ MHz}, V_{IN} = -0.5\text{ dBFS}$	70		dB
		$f_{IN} = 4.4\text{ MHz}, V_{IN} = -0.5\text{ dBFS}$	70		dB
		$f_{IN} = 10.1\text{ MHz}, V_{IN} = -0.5\text{ dBFS}$	70	66	dB (min)
SINAD	Signal-to-Noise and Distortion	$f_{IN} = 1\text{ MHz}, V_{IN} = -0.5\text{ dBFS}$	70		dB
		$f_{IN} = 4.4\text{ MHz}, V_{IN} = -0.5\text{ dBFS}$	70		dB
		$f_{IN} = 10.1\text{ MHz}, V_{IN} = -0.5\text{ dBFS}$	69	66	dB (min)
ENOB	Effective Number of Bits	$f_{IN} = 1\text{ MHz}, V_{IN} = -0.5\text{ dBFS}$	11.4		dB
		$f_{IN} = 4.4\text{ MHz}, V_{IN} = -0.5\text{ dBFS}$	11.4		dB
		$f_{IN} = 10.1\text{ MHz}, V_{IN} = -0.5\text{ dBFS}$	11.3	10.7	dB (min)
THD	Total Harmonic Distortion	$f_{IN} = 1\text{ MHz}, V_{IN} = -0.5\text{ dBFS}$	-88		dB
		$f_{IN} = 4.4\text{ MHz}, V_{IN} = -0.5\text{ dBFS}$	-86		dB
		$f_{IN} = 10.1\text{ MHz}, V_{IN} = -0.5\text{ dBFS}$	-79	-74	dB (min)
SFDR	Spurious Free Dynamic Range	$f_{IN} = 1\text{ MHz}, V_{IN} = -0.5\text{ dBFS}$	92		dB
		$f_{IN} = 4.4\text{ MHz}, V_{IN} = -0.5\text{ dBFS}$	89		dB
		$f_{IN} = 10.1\text{ MHz}, V_{IN} = -0.5\text{ dBFS}$	83	69	dB (min)
IMD	Intermodulation Distortion	$f_{IN} = 4.7\text{ MHz and } 4.9\text{ MHz, each} = -7\text{ dBFS}$	-75		dBFS

Symbol	Parameter	Conditions	Typical (Note 10)	Limits (Note 10)	Units (Limits)
REFERENCE AND ANALOG INPUT CHARACTERISTICS					
V_{CM}	Common Mode Input Voltage		$V_A / 2$		V
C_{IN}	V_{IN} Input Capacitance (each pin to GND)	$V_{IN} = 2.5 V_{dc} + 0.7 V_{rms}$	(CLK LOW)	8	pF
			(CLK HIGH)	7	pF
V_{REF}	Reference Voltage (Note 13)		2.00	1.0	V (min)
				2.4	V (max)
	Reference Input Resistance		100		MΩ(min)

DC and Logic Electrical Characteristics

Unless otherwise specified, the following specifications apply for AGND = DGND = DR GND = 0V, $V_A = V_D = +5V$, $V_{DR} = +3.0V$, PD = 0V, $V_{REF} = +2.0V$, $f_{CLK} = 10$ MHz, $t_r = t_f = 3$ ns, $C_L = 25$ pF/pin. **Boldface limits apply for $T_A = T_J = T_{MIN}$ to T_{MAX}** ; all other limits $T_A = T_J = 25^\circ C$ (Notes 7, 8, 9)

Symbol	Parameter	Conditions	Typical (Note 10)	Limits (Note 10)	Units (Limits)
CLK, PD, \overline{OE} DIGITAL INPUT CHARACTERISTICS					
$V_{IN(1)}$	Logical "1" Input Voltage	$V_D = 5.25V$		2.0	V (min)
$V_{IN(0)}$	Logical "0" Input Voltage	$V_D = 4.75V$		1.0	V (max)
$I_{IN(1)}$	Logical "1" Input Current	$V_{IN} = 5.0V$	10		μA
$I_{IN(0)}$	Logical "0" Input Current	$V_{IN} = 0V$	-10		μA
C_{IN}	Digital Input Capacitance		5		pF
D0–D11 DIGITAL OUTPUT CHARACTERISTICS					
$V_{OUT(1)}$	Logical "1" Output Voltage	$I_{OUT} = -0.5$ mA	$V_{DR} = 2.5V$	2.3	V (min)
			$V_{DR} = 3V$	2.7	V (min)
$V_{OUT(0)}$	Logical "0" Output Voltage	$I_{OUT} = 1.6$ mA, $V_{DR} = 3V$		0.4	V (max)
I_{OZ}	TRI-STATE Output Current	$V_{OUT} = 2.5V$ or $5V$	100		nA
		$V_{OUT} = 0V$	-100		nA
$+I_{SC}$	Output Short Circuit Source Current	$V_{OUT} = 0V$	-20		mA (min)
$-I_{SC}$	Output Short Circuit Sink Current	$V_{OUT} = V_{DR}$	20		mA (min)
POWER SUPPLY CHARACTERISTICS					
I_A	Analog Supply Current	PD Pin = DGND, $V_{REF} = 2.0V$	30	39	mA (max)
		PD Pin = V_{DR}	2.8		mA
I_D	Digital Supply Current	PD Pin = DGND	2	2.5	mA (max)
		PD Pin = V_{DR} , $f_{CLK} = 0$	2.2		mA
I_{DR}	Digital Output Supply Current	PD Pin = DGND, $C_L = 0$ pF (Note 14)	0		mA
		PD Pin = V_{DR} , $f_{CLK} = 0$	0		mA
	Total Power Consumption	PD Pin = DGND, $C_L = 0$ pF (Note 15)	160	207	mW
		PD Pin = V_{DR} , $f_{CLK} = 0$	25		mW
PSRR1+	Power Supply Rejection Ratio	Rejection of Positive Full-Scale Error with $V_A = 4.75V$ vs. $5.25V$	69		dBFS
PSRR1-	Power Supply Rejection Ratio	Rejection of Negative Full-Scale Error with $V_A = 4.75V$ vs. $5.25V$	51		dBFS
PSRR2	Power Supply Rejection Ratio	Rejection of Power Supply Noise with 10 MHz, 250 mV _{P-P} riding on V_A	48		dBFS

AC Electrical Characteristics

Unless otherwise specified, the following specifications apply for AGND = DGND = DR GND = 0V, $V_A = V_D = +5V$, $V_{DR} = +3.0V$, PD = 0V, $V_{REF} = +2.0V$, $f_{CLK} = 10$ MHz, $t_r = t_f = 3$ ns, $C_L = 25$ pF/pin. **Boldface limits apply for $T_A = T_J = T_{MIN}$ to T_{MAX}** : all other limits $T_A = T_J = 25^\circ\text{C}$ (Notes 7, 8, 9, 12)

Symbol	Parameter	Conditions	Typical (Note 10)	Limits (Note 10)	Units (Limits)
f_{CLK1}	Maximum Clock Frequency		10	15	MHz (min)
f_{CLK2}	Minimum Clock Frequency		100		kHz
t_{CH}	Clock High Time			30	ns (min)
t_{CL}	Clock Low Time			30	ns(min)
t_{CONV}	Conversion Latency			6	Clock Cycles
t_{OD}	Data Output Delay after Rising CLK Edge	$V_{DR} = 2.5V$	11	16.8	ns (max)
		$V_{DR} = 3.0V$	11	16.8	ns (max)
t_{AD}	Aperture Delay		1.2		ns
t_{AJ}	Aperture Jitter		2		ps rms
t_{DIS}	Data outputs into TRI-STATE Mode		4		ns
t_{EN}	Data Outputs Active after TRI-STATE		4		ns
t_{PD}	Power Down Mode Exit Cycle	0.1 μF cap on pins 30, 31,32	500		ns

Note 1: Absolute Maximum Ratings indicate limits beyond which damage to the device may occur. Operating Ratings indicate conditions for which the device is functional, but do not guarantee specific performance limits. For guaranteed specifications and test conditions, see the Electrical Characteristics. The guaranteed specifications apply only for the test conditions listed. Some performance characteristics may degrade when the device is not operated under the listed test conditions.

Note 2: All voltages are measured with respect to GND = AGND = DGND = 0V, unless otherwise specified.

Note 3: When the input voltage at any pin exceeds the power supplies (that is, $V_{IN} < \text{AGND}$, or $V_{IN} > V_A$), the current at that pin should be limited to 25 mA. The 50 mA maximum package input current rating limits the number of pins that can safely exceed the power supplies with an input current of 25 mA to two.

Note 4: The absolute maximum junction temperature (T_{Jmax}) for this device is 150°C . The maximum allowable power dissipation is dictated by T_{Jmax} , the junction-to-ambient thermal resistance (θ_{JA}), and the ambient temperature, (T_A), and can be calculated using the formula $P_{DMAX} = (T_{Jmax} - T_A) / \theta_{JA}$. The values for maximum power dissipation listed above will be reached only when the device is operated in a severe fault condition (e.g. when input or output pins are driven beyond the power supply voltages, or the power supply polarity is reversed). Obviously, such conditions should always be avoided.

Note 5: Human body model is 100 pF capacitor discharged through a 1.5 k Ω resistor. Machine model is 220 pF discharged through 0 Ω .

Note 6: The 235°C reflow temperature refers to infrared reflow. For Vapor Phase Reflow (VPR), the following Conditions apply: Maintain the temperature at the top of the package body above 183°C for a minimum 60 seconds. The temperature measured on the package body must not exceed 220°C . Only one excursion above 183°C is allowed per reflow cycle.

Note 7: The inputs are protected as shown below. Input voltage magnitudes above V_A or below GND will not damage this device, provided current is limited per (Note 3). However, errors in the A/D conversion can occur if the input goes above V_A or below GND by more than 100 mV. As an example, if V_A is 4.75V, the full-scale input voltage must be $\leq 4.85V$ to ensure accurate conversions.

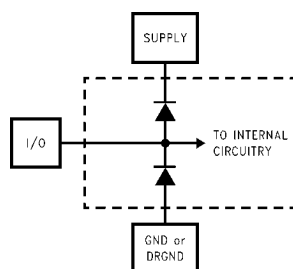

20051607

Note 8: To guarantee accuracy, it is required that $|V_A - V_D| \leq 100$ mV and separate bypass capacitors are used at each power supply pin.

Note 9: With the test condition for $V_{REF} = +2.0V$ (4V_{P-P} differential input), the 12-bit LSB is 977 μV .

Note 10: Typical figures are at $T_A = T_J = 25^\circ\text{C}$, and represent most likely parametric norms. Test limits are guaranteed to National's AOQL (Average Outgoing Quality Level).

Note 11: Integral Non Linearity is defined as the deviation of the analog value, expressed in LSBs, from the straight line that passes through positive and negative full-scale.

Note 12: Timing specifications are tested at TTL logic levels, $V_{IL} = 0.4V$ for a falling edge and $V_{IH} = 2.4V$ for a rising edge.

Note 13: Optimum performance will be obtained by keeping the reference input in the 1.8V to 2.2V range. The LM4051CIM3-ADJ (SOT-23 package) is recommended for this application.

Note 14: I_{DR} is the current consumed by the switching of the output drivers and is primarily determined by load capacitance on the output pins, the supply voltage, V_{DR} , and the rate at which the outputs are switching (which is signal dependent). $I_{DR} = V_{DR}(C_0 \times f_0 + C_1 \times f_1 + \dots + C_{11} \times f_{11})$ where V_{DR} is the output driver power supply voltage, C_n is total capacitance on the output pin, and f_n is the average frequency at which that pin is toggling.

Note 15: Excludes I_{DR} . See note 14.

Specification Definitions

APERTURE DELAY is the time after the rising edge of the clock to when the input signal is acquired or held for conversion.

APERTURE JITTER (APERTURE UNCERTAINTY) is the variation in aperture delay from sample to sample. Aperture jitter manifests itself as noise in the output.

CLOCK DUTY CYCLE is the ratio of the time during one cycle that a repetitive digital waveform is high to the total time of one period. The specification here refers to the ADC clock input signal.

COMMON MODE VOLTAGE (V_{CM}) is the d.c. potential present at both signal inputs to the ADC.

CONVERSION LATENCY is the number of clock cycles between initiation of conversion and when that data is presented to the output driver stage. Data for any given sample is available at the output pins the Pipeline Delay plus the Output Delay after the sample is taken. New data is available at every clock cycle, but the data lags the conversion by the pipeline delay.

DIFFERENTIAL NON-LINEARITY (DNL) is the measure of the maximum deviation from the ideal step size of 1 LSB.

EFFECTIVE NUMBER OF BITS (ENOB, or EFFECTIVE BITS) is another method of specifying Signal-to-Noise and Distortion or SINAD. ENOB is defined as $(\text{SINAD} - 1.76) / 6.02$ and says that the converter is equivalent to a perfect ADC of this (ENOB) number of bits.

FULL POWER BANDWIDTH is a measure of the frequency at which the reconstructed output fundamental drops 3 dB below its low frequency value for a full scale input.

GAIN ERROR is the deviation from the ideal slope of the transfer function. It is the difference between the Positive Full Scale Error and the Negative Full Scale Error:

$$\text{Gain Error} = \text{Pos. Full Scale Error} - \text{Neg. Full Scale Error}$$

INTEGRAL NON LINEARITY (INL) is a measure of the deviation of each individual code from a line drawn from negative full scale ($\frac{1}{2}$ LSB below the first code transition) through positive full scale ($\frac{1}{2}$ LSB above the last code transition). The deviation of any given code from this straight line is measured from the center of that code value.

INTERMODULATION DISTORTION (IMD) is the creation of additional spectral components as a result of two sinusoidal frequencies being applied to the ADC input at the same time. It is defined as the ratio of the power in the intermodulation products to the total power in the original frequencies. IMD is usually expressed in dBFS.

MISSING CODES are those output codes that will never appear at the ADC outputs. The ADC12010 is guaranteed not to have any missing codes.

NEGATIVE FULL SCALE ERROR is the difference between the actual first code transition and its ideal value of $\frac{1}{2}$ LSB above negative full scale.

OFFSET ERROR is the difference between the two input voltages ($V_{IN+} - V_{IN-}$) required to cause a transition from code 2047 to 2048.

OUTPUT DELAY is the time delay after the rising edge of the clock before the data update is presented at the output pins.

PIPELINE DELAY (LATENCY) See CONVERSION LATENCY

POSITIVE FULL SCALE ERROR is the difference between the actual last code transition and its ideal value of $\frac{1}{2}$ LSB below positive full scale.

POWER SUPPLY REJECTION RATIO (PSRR) is a measure of how well the ADC rejects a change in the power supply voltage. For the ADC12010, PSRR1 is the ratio of the change in Full-Scale Error that results from a change in the dc power supply voltage, expressed in dB. PSRR2 is a measure of how well an a.c. signal riding upon the power supply is rejected at the output.

SIGNAL TO NOISE RATIO (SNR) is the ratio, expressed in dB, of the rms value of the input signal to the rms value of the sum of all other spectral components below one-half the sampling frequency, not including harmonics or dc.

SIGNAL TO NOISE PLUS DISTORTION (S/N+D or SINAD) Is the ratio, expressed in dB, of the rms value of the input signal to the rms value of all of the other spectral components below half the clock frequency, including harmonics but excluding dc.

SPURIOUS FREE DYNAMIC RANGE (SFDR) is the difference, expressed in dB, between the desired signal amplitude to the amplitude of the peak spurious spectral component, where a spurious spectral component is any signal present in the output spectrum that is not present at the input and may or may not be a harmonic.

TOTAL HARMONIC DISTORTION (THD) is the ratio, expressed in dBc, of the rms total of the first nine harmonic levels at the output to the level of the fundamental at the output. THD is calculated as

$$\text{THD} = 20 \times \log \sqrt{\frac{f_2^2 + \dots + f_{10}^2}{f_1^2}}$$

where f_1 is the RMS power of the fundamental (output) frequency and f_2 through f_{10} are the RMS power in the first 9 harmonic frequencies.

Timing Diagram

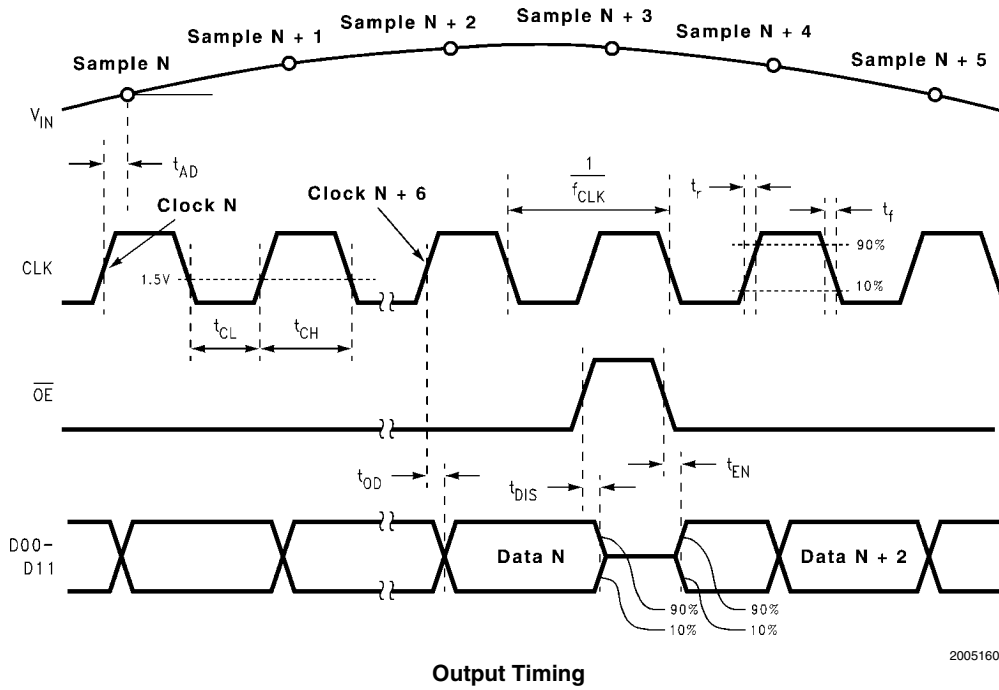

20051609

Transfer Characteristic

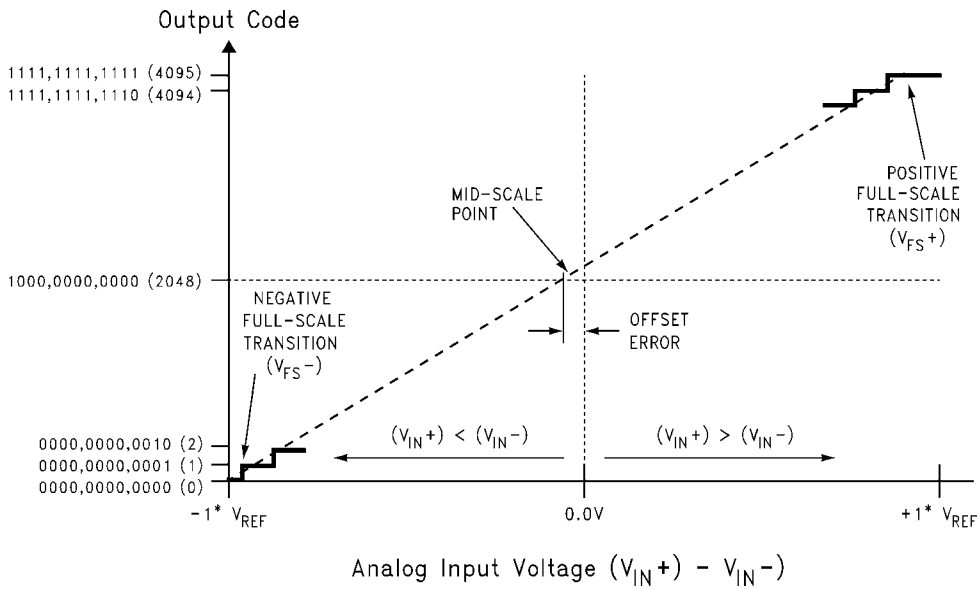

20051610

FIGURE 1. Transfer Characteristic

ADC12010 Typical Performance Characteristics $V_A = V_D = 5.0V$, $V_{DR} = 3.0V$, $f_{CLK} = 10\text{ MHz}$,
 $f_{IN} = 10.1\text{ MHz}$, $V_{REF} = 2.0V$ unless otherwise stated

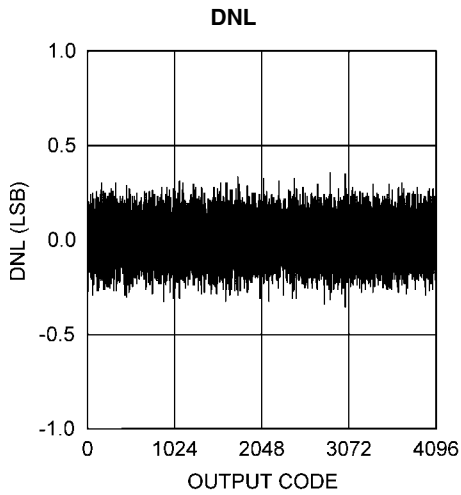

20051638

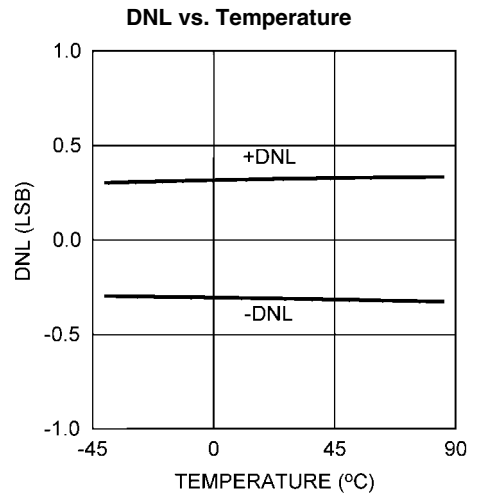

20051639

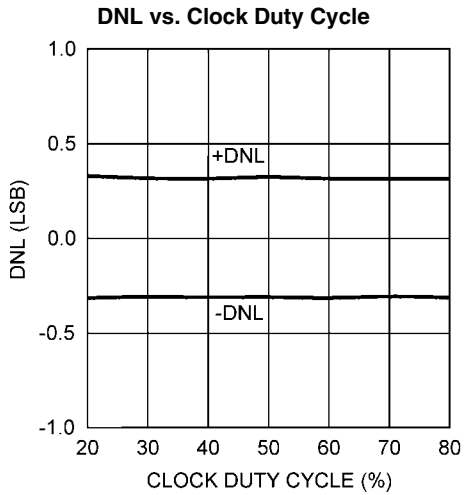

20051640

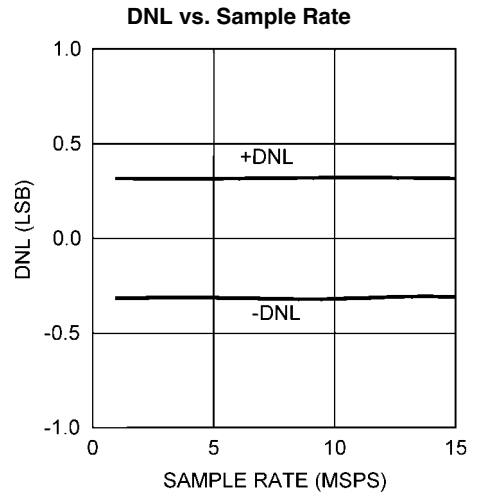

20051641

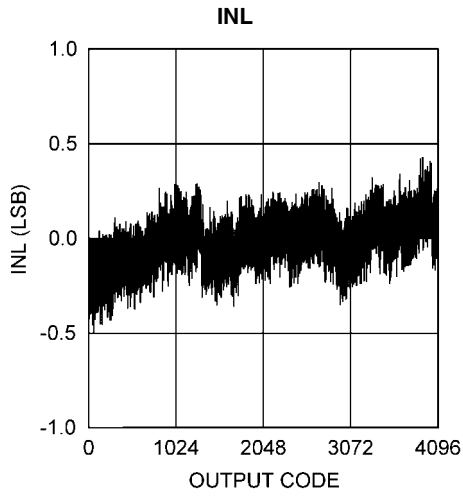

20051642

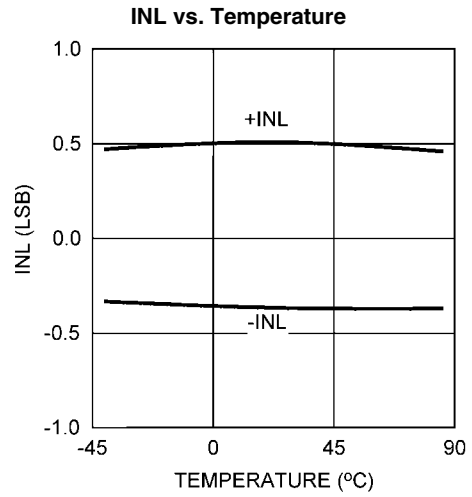

20051643

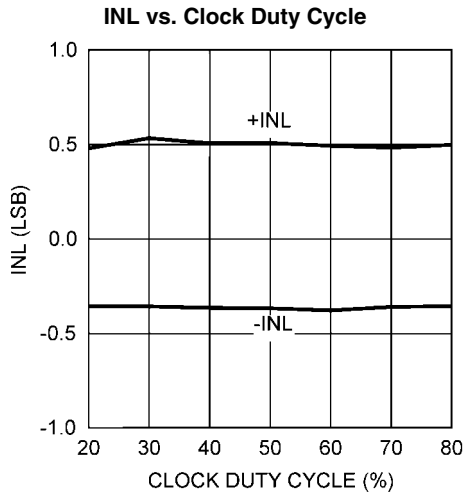

20051644

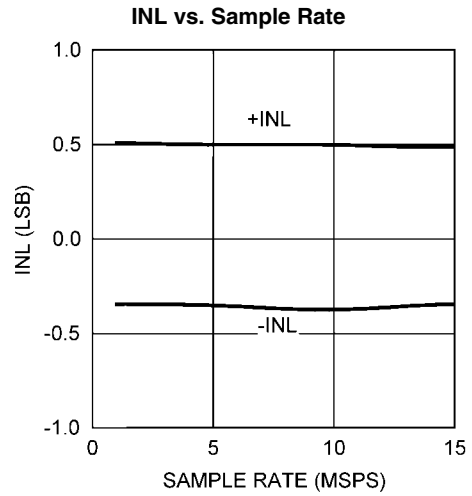

20051645

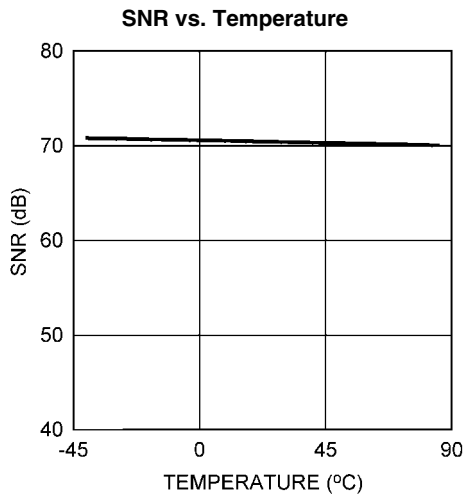

20051646

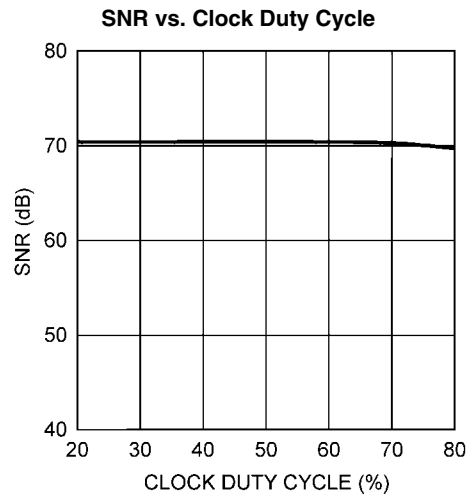

20051647

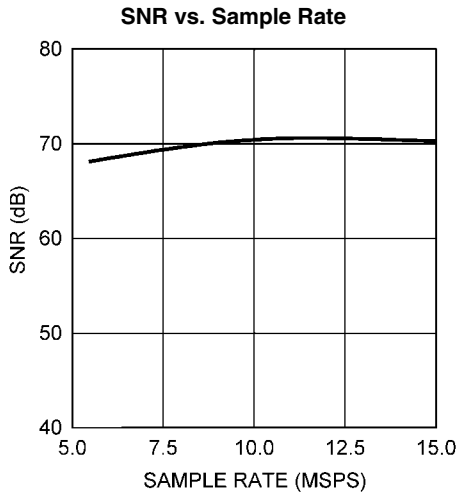

20051648

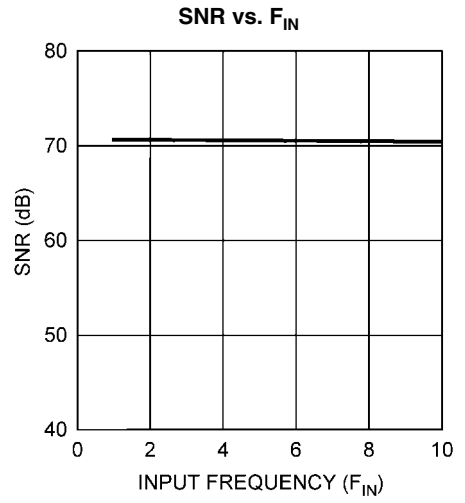

20051649

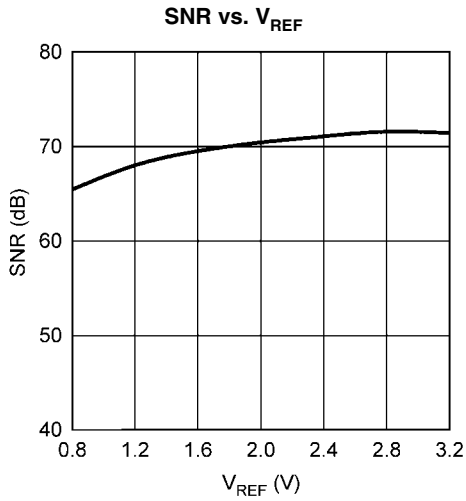

20051650

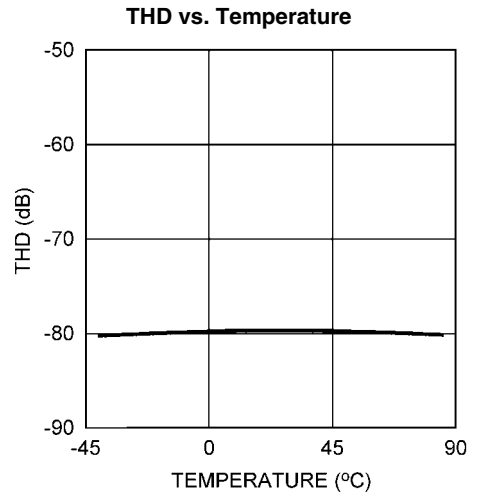

20051651

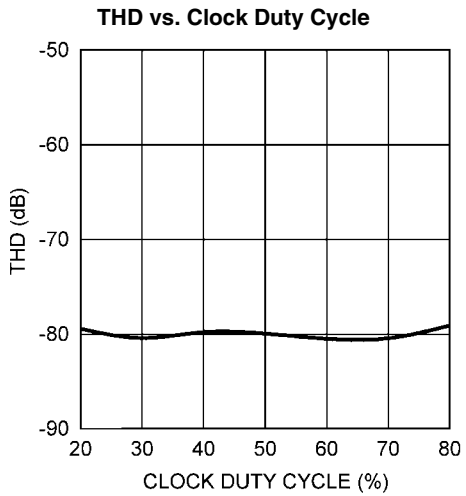

20051652

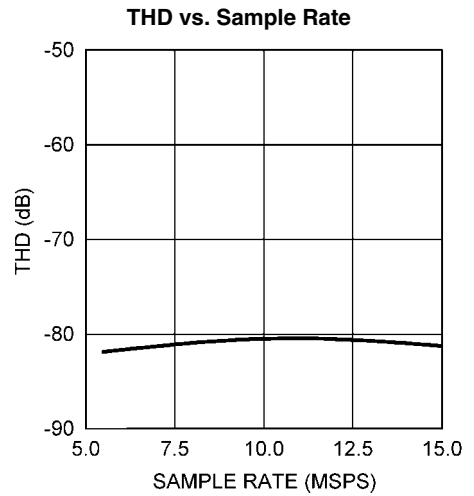

20051653

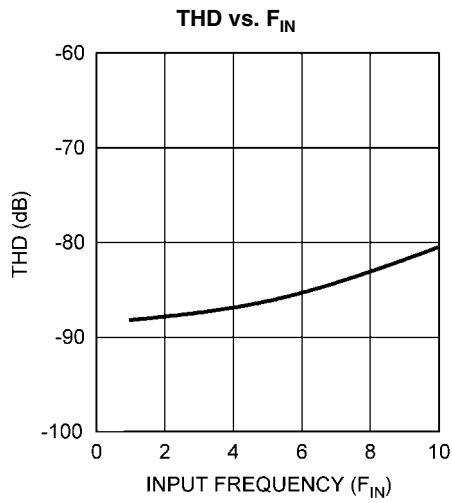

20051654

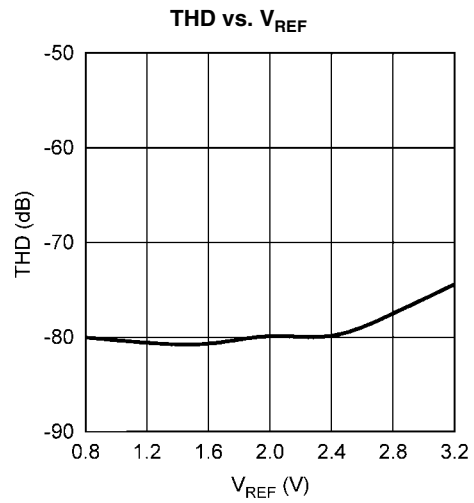

20051655

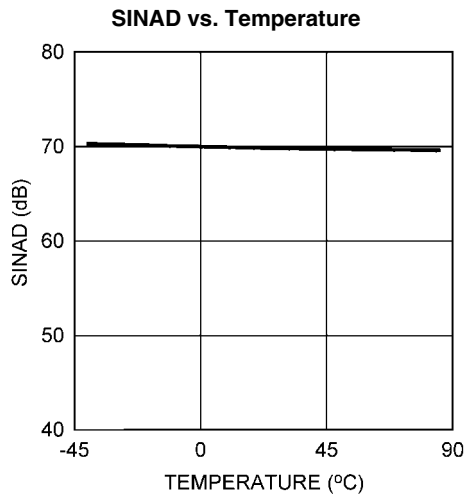

20051656

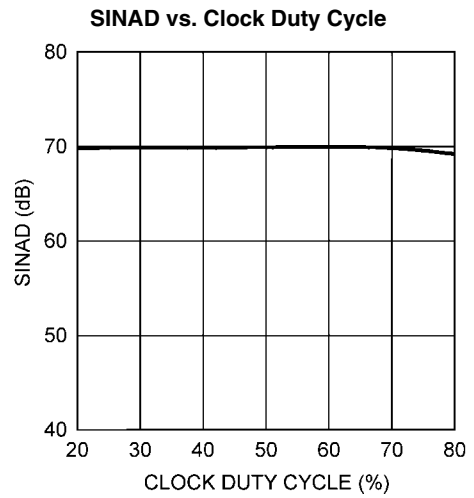

20051657

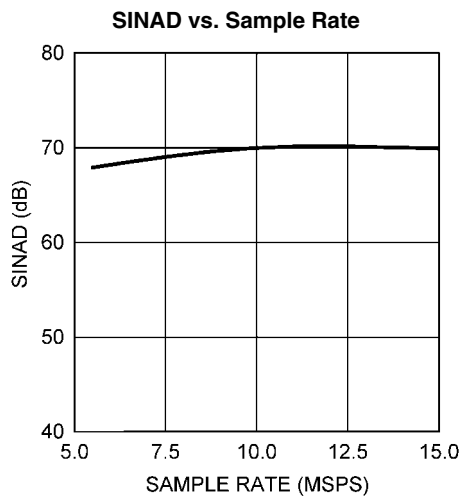

20051658

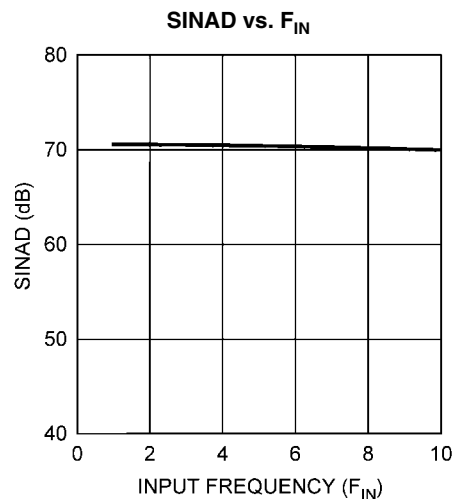

20051659

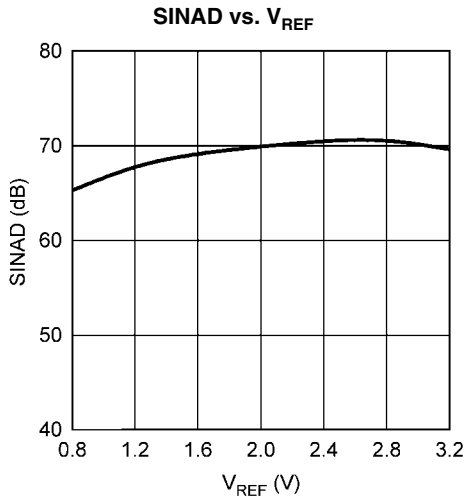

20051660

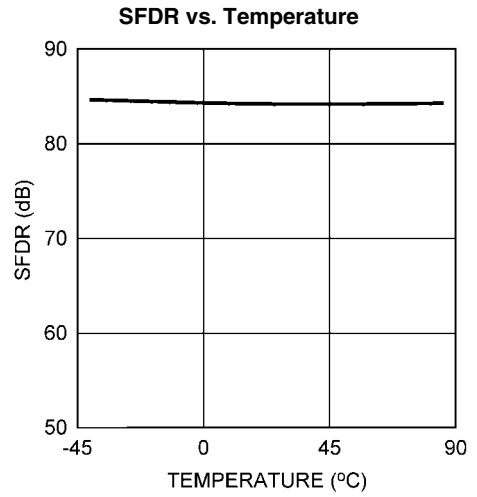

20051661

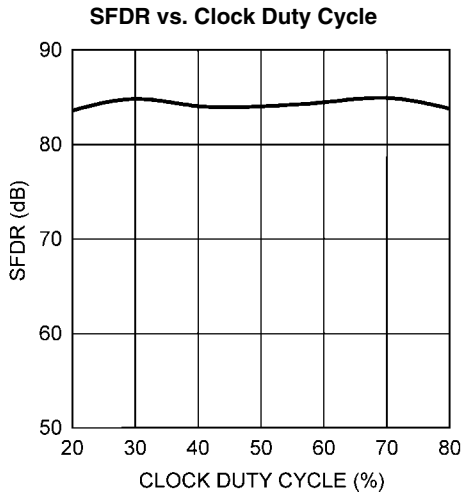

20051662

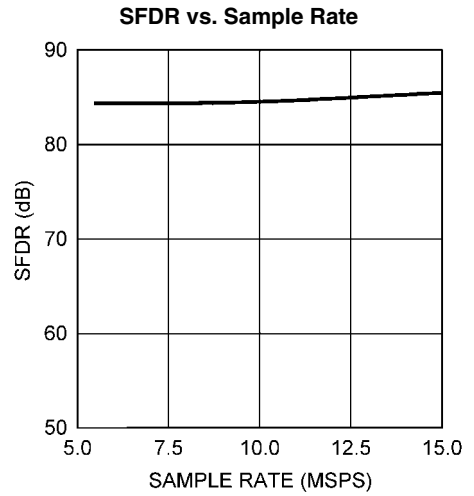

20051663

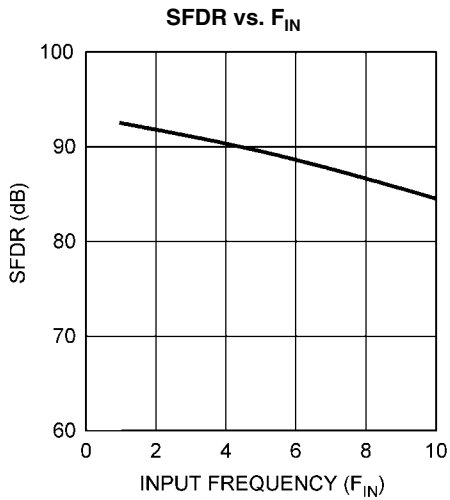

20051664

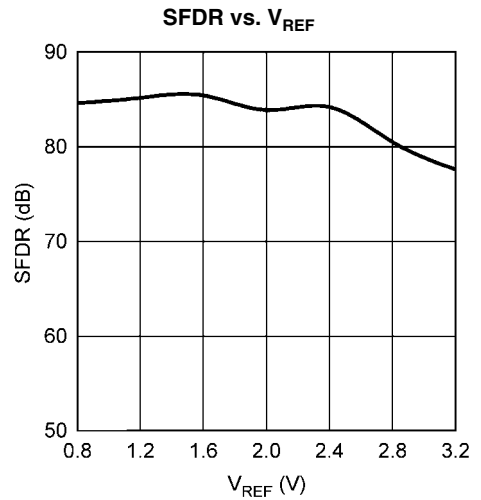

20051665

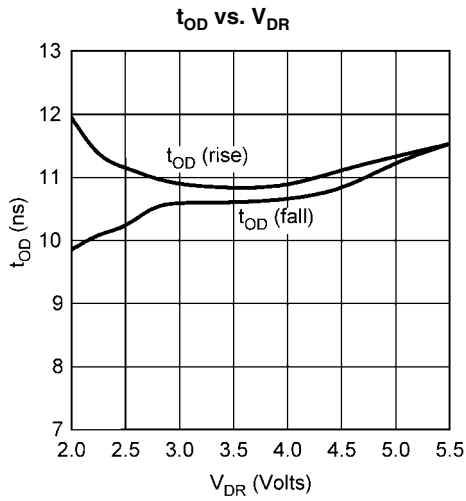

20051669

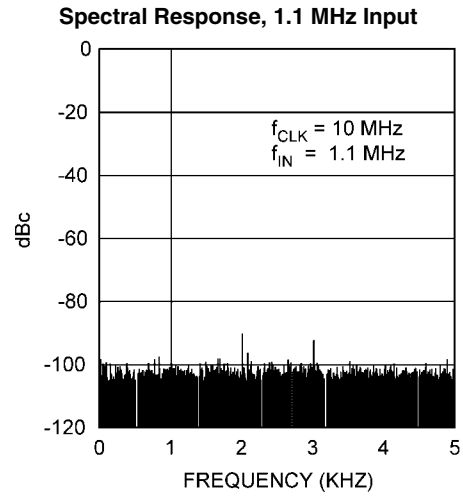

20051666

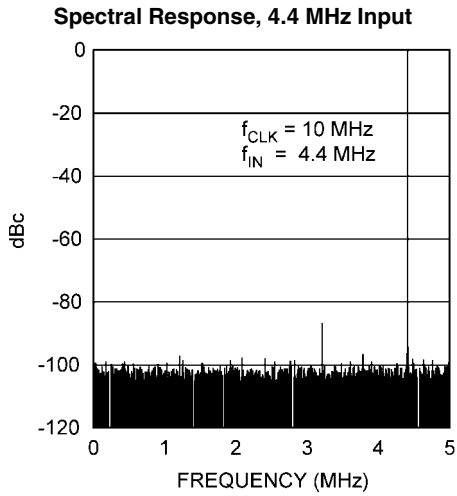

20051667

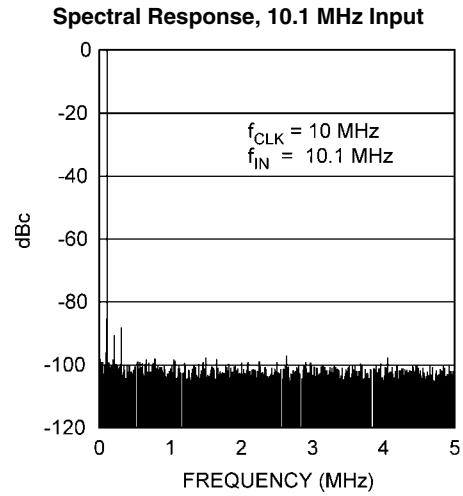

20051668

Functional Description

Operating on a single +5V supply, the ADC12010 uses a pipeline architecture with error correction circuitry to help ensure maximum performance. The differential analog input signal is digitized to 12 bits.

The reference input is buffered to ease the task of driving that pin. The output word rate is the same as the clock frequency. The analog input voltage is acquired at the rising edge of the clock and the digital data for a given sample is delayed by the pipeline for 6 clock cycles.

A logic high on the power down (PD) pin reduces the converter power consumption to 40 mW.

Applications Information

1.0 OPERATING CONDITIONS

We recommend that the following conditions be observed for operation of the ADC12010:

$$4.75V \leq V_A \leq 5.25V$$

$$V_D = V_A$$

$$2.35V \leq V_{DR} \leq V_D$$

$$100 \text{ kHz} \leq f_{CLK} \leq 15 \text{ MHz}$$

$$1.0V \leq V_{REF} \leq 2.4V$$

$$1.0V \leq V_{CM} \leq 4.0V$$

1.1 Analog Inputs

The ADC12010 has two analog signal inputs, V_{IN+} and V_{IN-} . These two pins form a differential input pair. There is one reference input pin, V_{REF} .

1.2 Reference Pins

The ADC12010 is designed to operate with a 2.0V reference, but performs well with reference voltages in the range of 1.0V to 2.4V. Lower reference voltages will decrease the signal-to-noise ratio (SNR). Increasing the reference voltage (and the input signal swing) beyond 2.4V will degrade THD for a full-scale input.

It is important that all grounds associated with the reference voltage and the input signal make connection to the ground plane at a single point to minimize the effects of noise currents in the ground path.

The three Reference Bypass Pins (V_{RP} , V_{RM} and V_{RN}) are made available for bypass purposes. These pins should each be bypassed to ground with a 0.1 μ F capacitor. Smaller capacitor values will allow faster recovery from the power down mode, but may result in degraded noise performance. DO NOT LOAD these pins.

1.3 Signal Inputs

The signal inputs are V_{IN+} and V_{IN-} . The input signal, V_{IN} , is defined as

$$V_{IN} = (V_{IN+}) - (V_{IN-})$$

Figure 2 shows the expected input signal range.

Note that the common mode input voltage range is 1V to 3V with a nominal value of $V_A/2$. The input signals should remain between ground and 4V.

The Peaks of the individual input signals (V_{IN+} and V_{IN-}) should each never exceed the voltage described as

$$V_{IN+}, V_{IN-} = V_{REF} + V_{CM}$$

to maintain THD and SINAD performance.

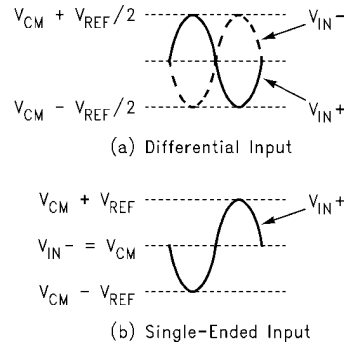

20051611

FIGURE 2. Expected Input Signal Range

The ADC12010 performs best with a differential input with each input centered around V_{CM} . The peak-to-peak voltage swing at both V_{IN+} and V_{IN-} each should not exceed the value of the reference voltage or the output data will be clipped. The two input signals should be exactly 180° out of phase from each other and of the same amplitude. For single frequency inputs, angular errors result in a reduction of the effective full scale input. For a complex waveform, however, angular errors will result in distortion.

For angular deviations of up to 10 degrees from these two signals being 180 out of phase, the full scale error in LSB can be described as approximately

$$E_{FS} = 4096 (1 - \sin(90^\circ + dev))$$

Where dev is the angular difference, in degrees, between the two signals having a 180° relative phase relationship to each other (see Figure 3). Drive the analog inputs with a source impedance less than 100 Ω .

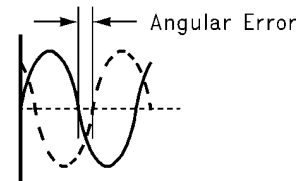

20051612

FIGURE 3. Angular Errors Between the Two Input Signals Will Reduce the Output Level

For differential operation, each analog input signal should have a peak-to-peak voltage equal to the input reference voltage, V_{REF} , and be centered around a common mode voltage, V_{CM} .

TABLE 1. Input to Output Relationship—Differential Input

V_{IN+}	V_{IN-}	Output
$V_{CM} - V_{REF}/2$	$V_{CM} + V_{REF}/2$	0000 0000 0000
$V_{CM} - V_{REF}/4$	$V_{CM} + V_{REF}/4$	0100 0000 0000
V_{CM}	V_{CM}	1000 0000 0000
$V_{CM} + V_{REF}/4$	$V_{CM} - V_{REF}/4$	1100 0000 0000
$V_{CM} + V_{REF}/2$	$V_{CM} - V_{REF}/2$	1111 1111 1111

TABLE 2. Input to Output Relationship—Single-Ended Input

V_{IN+}	V_{IN-}	Output
$V_{CM} - V_{REF}$	V_{CM}	0000 0000 0000
$V_{CM} - V_{REF}/2$	V_{CM}	0100 0000 0000
V_{CM}	V_{CM}	1000 0000 0000
$V_{CM} + V_{REF}/2$	V_{CM}	1100 0000 0000
$V_{CM} + V_{REF}$	V_{CM}	1111 1111 1111

1.3.1 Single-Ended Operation

Single-ended performance is lower than with differential input signals. For this reason, single-ended operation is not recommended. However, if single ended-operation is required, and the resulting performance degradation is acceptable, one of the analog inputs should be connected to the d.c. common mode voltage of the driven input. The peak-to-peak differential input signal should be twice the reference voltage to maximize SNR and SINAD performance (*Figure 2b*). For example, set V_{REF} to 1.0V, bias V_{IN-} to 1.0V and drive V_{IN+} with a signal range of 0V to 2.0V.

Because very large input signal swings can degrade distortion performance, better performance with a single-ended input can be obtained by reducing the reference voltage when maintaining a full-range output. and indicate the input to output relationship of the ADC12010.

1.3.2 Driving the Analog Input

The V_{IN+} and the V_{IN-} inputs of the ADC12010 consist of an analog switch followed by a switched-capacitor amplifier. The capacitance seen at the analog input pins changes with the clock level, appearing as 8 pF when the clock is low, and 7 pF when the clock is high. Although this difference is small, a dynamic capacitance is more difficult to drive than is a fixed capacitance, so choose the driving amplifier carefully. The LMH6550, the LMH6702 and the LMH6628 are good amplifiers for driving the ADC12010.

The internal switching action at the analog inputs causes energy to be output from the input pins. As the driving source tries to compensate for this, it adds noise to the signal. To prevent this, use an RC at each of the inputs, as shown in *Figure 5* and *Figure 6*. These components should be placed close to the ADC because the input pins of the ADC is the most sensitive part of the system and this is the last opportunity to filter the input. The capacitors should be eliminated for undersampling applications.

The LMH6550 and the LMH6552 are excellent devices for driving the ADC12010, especially when single-ended to differential conversion with d.c. coupling is necessary. An example of the use of the LMH6550 to drive the analog input of the ADC12010 is shown in *Figure 5*.

For high frequency, narrow band applications, a transformer is generally the recommended way to drive the analog inputs, as shown in *Figure 6*.

1.3.3 Input Common Mode Voltage

The input common mode voltage, V_{CM} , should be in the range of 0.5V to 4.0V and be of a value such that the peak excursions of the analog signal does not go more negative than ground or more positive than 0.5 Volts below the V_A supply voltage. The nominal V_{CM} should generally be equal to $V_{REF}/2$, but V_{RM} can be used as a V_{CM} source as long as V_{CM} need not supply more than 10 μ A of current. *Figure 5* shows the use of the V_{RM} output to drive the V_{CM} input of the

LMH6550. The common mode output voltage of the LMH6550 is equal to the V_{CM} input input voltage.

2.0 DIGITAL INPUTS

The digital TTL/CMOS compatible inputs consist of CLK, \overline{OE} and PD.

2.1 CLK

The **CLK** signal controls the timing of the sampling process. Drive the clock input with a stable, low jitter clock signal in the range of 100 kHz to 15 MHz with rise and fall times of less than 3ns. The trace carrying the clock signal should be as short as possible and should not cross any other signal line, analog or digital, not even at 90°.

If the **CLK** is interrupted, or its frequency too low, the charge on internal capacitors can dissipate to the point where the accuracy of the output data will degrade. This is what limits the lowest sample rate to 100 ksp/s.

The duty cycle of the clock signal can affect the performance of the A/D Converter. Because achieving a precise duty cycle is difficult, the ADC12010 is designed to maintain performance over a range of duty cycles. While it is specified and performance is guaranteed with a 50% clock duty cycle, performance is typically maintained over a clock duty cycle range of 30% to 70%.

The clock line should be terminated at its source in the characteristic impedance of that line. It is highly desirable that the the source driving the ADC **CLK** pin only drive that pin. However, if that source is used to drive other things, each driven pin should be a.c. terminated with a series RC to ground, as shown in *Figure 4*, such that the resistor value is equal to the characteristic impedance of the clock line and the capacitor value is

$$C \geq \frac{4 \times t_{PR} \times L}{Z_0}$$

where t_{PR} is the signal propagation rate down the clock line, "L" is the line length and Z_0 is the characteristic impedance of the clock line. This termination should be as close as possible to the ADC clock pin but beyond it as seen from the clock source. Typical t_{PD} is about 150 ps/inch (60 ps/cm) on FR-4 board material. The units of "L" and t_{PD} should be the same (inches or centimeters).

Take care to maintain a constant clock line impedance throughout the length of the line. Refer to Application Note AN-905 or AN-1113 for information on setting and determining characteristic impedance.

2.2 The \overline{OE} Input

The \overline{OE} pin, when high, puts the output pins into a high impedance state. When this pin is low the outputs are in the active state. The ADC12010 will continue to convert whether this pin is high or low, but the output can not be read while the \overline{OE} pin is high.

The \overline{OE} pin should NOT be used to multiplex devices together to drive a common bus as this will result in excessive capacitance on the data output pins, reducing SNR and SINAD performance of the converter. See Section 3.0.

2.3 PD

The PD pin, when high, holds the ADC12010 in a power-down mode to conserve power when the converter is not being used. The power consumption in this state is 25 mW with a 10 Mhz clock and the output data pins are undefined in this

COMMON GROUND PLANE

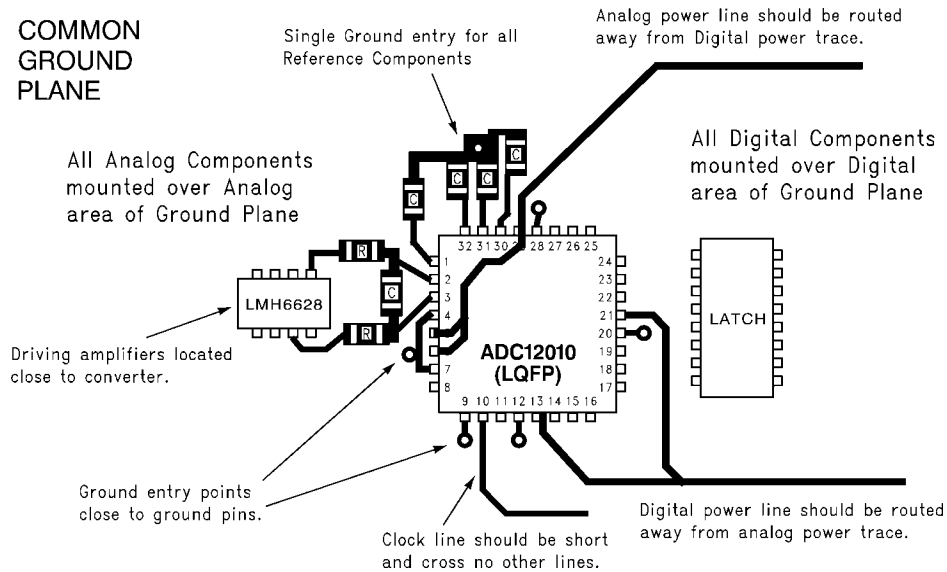

20051616

FIGURE 7. Example of a Suitable Layout

Since digital switching transients are composed largely of high frequency components, total ground plane copper weight will have little effect upon the logic-generated noise. This is because of the skin effect. Total surface area is more important than is total ground plane volume.

Generally, analog and digital lines should cross each other at 90° to avoid crosstalk. To maximize accuracy in high speed, high resolution systems, however, avoid crossing analog and digital lines altogether. It is important to keep clock lines as short as possible and isolated from ALL other lines, including other digital lines. Even the generally accepted 90° crossing should be avoided with the clock line as even a little coupling can cause problems at high frequencies. This is because other lines can introduce jitter into the clock line, which can lead to degradation of SNR. Also, the high speed clock can introduce noise into the analog chain.

Best performance at high frequencies and at high resolution is obtained with a straight signal path. That is, the signal path through all components should form a straight line wherever possible.

Be especially careful with the layout of inductors. Mutual inductance can change the characteristics of the circuit in which they are used. Inductors should *not* be placed side by side, even with just a small part of their bodies beside each other. The analog input should be isolated from noisy signal traces to avoid coupling of spurious signals into the input. Any external component (e.g., a filter capacitor) connected between the converter's input pins and ground or to the reference input pin and ground should be connected to a very clean point in the analog ground plane.

Figure 7 gives an example of a suitable layout. A single ground plane is recommended with separate analog and digital power planes. The analog and digital power planes should NOT overlap each other. All analog circuitry (input amplifiers, filters, reference components, etc.) should be placed over the analog power plane. All digital circuitry and I/O lines should be placed over the digital power plane. Furthermore, all components in the reference circuitry and the input signal chain that are connected to ground should be connected together

with short traces and enter the ground plane at a single point. All ground connections should have a low inductance path to ground..

6.0 DYNAMIC PERFORMANCE

To achieve the best dynamic performance, the clock source driving the CLK input must be free of jitter. Isolate the ADC clock from any digital circuitry with buffers, as with the clock tree shown in Figure 8.

As mentioned in Section 5.0, it is good practice to keep the ADC clock line as short as possible and to keep it well away from any other signals. Other signals can introduce jitter into the clock signal, which can lead to reduced SNR performance, and the clock can introduce noise into other lines. Even lines with 90° crossings have capacitive coupling, so try to avoid even these 90° crossings of the clock line.

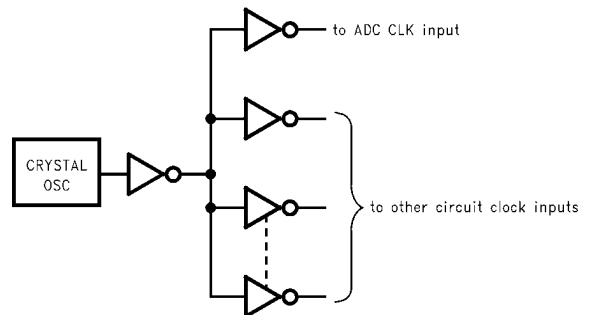

20051617

FIGURE 8. Isolating the ADC Clock from other Circuitry with a Clock Tree

7.0 COMMON APPLICATION PITFALLS

Driving the inputs (analog or digital) beyond the power supply rails. For proper operation, all inputs should not go more than 100 mV beyond the supply rails (more than 100 mV below the ground pins or 100 mV above the supply pins). Exceeding these limits on even a transient basis may

cause faulty or erratic operation. It is not uncommon for high speed digital components (e.g., 74F and 74AC devices) to exhibit overshoot or undershoot that goes above the power supply or below ground. A resistor of about 47Ω to 100Ω in series with any offending digital input, close to the signal source, will eliminate the problem.

Do not allow input voltages to exceed the supply voltage, even on a transient basis. Not even during power up or power down.

Be careful not to overdrive the inputs of the ADC12010 with a device that is powered from supplies outside the range of the ADC12010 supply. Such practice may lead to conversion inaccuracies and even to device damage.

Attempting to drive a high capacitance digital data bus.

The more capacitance the output drivers must charge for each conversion, the more instantaneous digital current flows through V_{DR} and DR GND. These large charging current spikes can couple into the analog circuitry, degrading dynamic performance. Adequate bypassing and maintaining separate analog and digital areas on the pc board will reduce this problem.

Additionally, bus capacitance beyond that specified will cause t_{OD} to increase, making it difficult to properly latch the ADC output data. The result could, again, be an apparent reduction in dynamic performance.

The digital data outputs should be buffered (with 74AC541, for example). Dynamic performance can also be improved by adding series resistors at each digital output, close to the ADC12010, which reduces the energy coupled back into the converter output pins by limiting the output current. A reasonable value for these resistors is 100Ω .

Using an inadequate amplifier to drive the analog input.

As explained in Section 1.3, the capacitance seen at the input

alternates between 8 pF and 7 pF , depending upon the phase of the clock. This dynamic load is more difficult to drive than is a fixed capacitance.

If the amplifier exhibits overshoot, ringing, or any evidence of instability, even at a very low level, it will degrade performance. A small series resistor and shunt capacitor at each amplifier output (as shown in *Figure 5* and *Figure 6*) will improve performance. The LMH6550, the LMH6702 and the LMH6628 have been successfully used to drive the analog inputs of the ADC12010.

Also, it is important that the signals at the two inputs have exactly the same amplitude and be exactly 180° out of phase with each other. Board layout, especially equality of the length of the two traces to the input pins, will affect the effective phase between these two signals. Remember that an operational amplifier operated in the non-inverting configuration will exhibit more time delay than will the same device operating in the inverting configuration.

Operating with the reference pins outside of the specified range. As mentioned in Section 1.2, V_{REF} should be in the range of

$$1.0V \leq V_{REF} \leq 2.4V$$

Operating outside of these limits could lead to performance degradation.

Using a clock source with excessive jitter, using excessively long clock signal trace, or having other signals coupled to the clock signal trace. This will cause the sampling interval to vary, causing excessive output noise and a reduction in SNR and SINAD performance.

Physical Dimensions inches (millimeters) unless otherwise noted

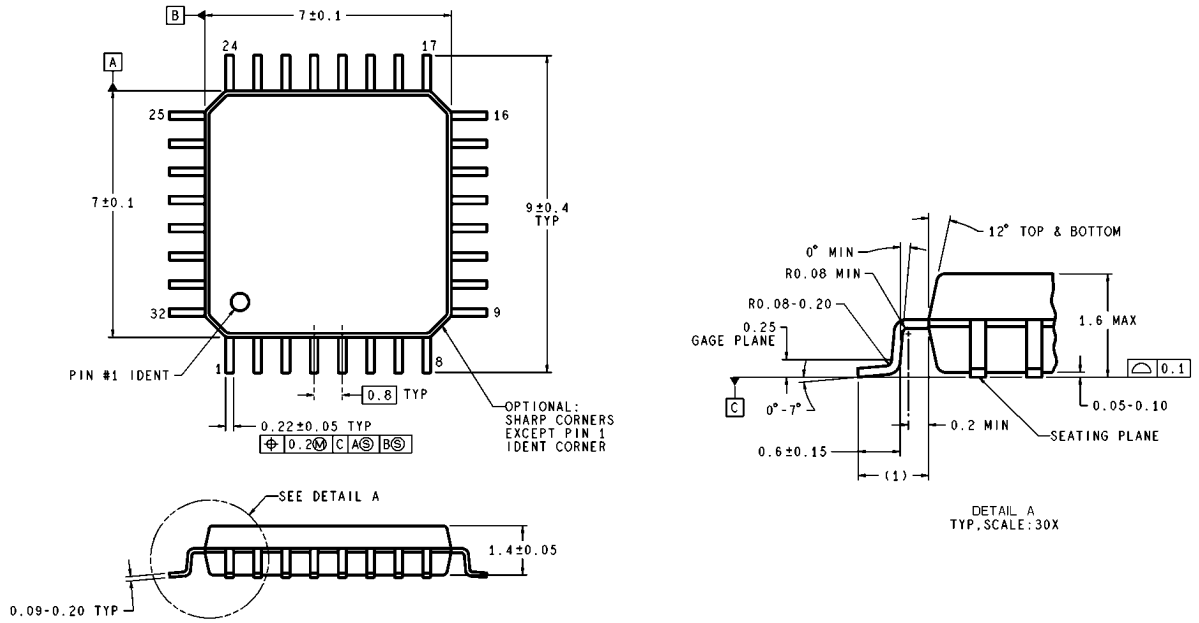

DIMENSIONS ARE IN MILLIMETERS

VBE32A (Rev E)

32-Lead LQFP Package
Ordering Number ADC12010CIVY
NS Package Number VBE32A

Notes

Notes

For more National Semiconductor product information and proven design tools, visit the following Web sites at:

Products		Design Support	
Amplifiers	www.national.com/amplifiers	WEBENCH	www.national.com/webench
Audio	www.national.com/audio	Analog University	www.national.com/AU
Clock Conditioners	www.national.com/timing	App Notes	www.national.com/appnotes
Data Converters	www.national.com/adc	Distributors	www.national.com/contacts
Displays	www.national.com/displays	Green Compliance	www.national.com/quality/green
Ethernet	www.national.com/ethernet	Packaging	www.national.com/packaging
Interface	www.national.com/interface	Quality and Reliability	www.national.com/quality
LVDS	www.national.com/lvds	Reference Designs	www.national.com/refdesigns
Power Management	www.national.com/power	Feedback	www.national.com/feedback
Switching Regulators	www.national.com/switchers		
LDOs	www.national.com/lido		
LED Lighting	www.national.com/led		
PowerWise	www.national.com/powerwise		
Serial Digital Interface (SDI)	www.national.com/sdi		
Temperature Sensors	www.national.com/tempsensors		
Wireless (PLL/VCO)	www.national.com/wireless		

THE CONTENTS OF THIS DOCUMENT ARE PROVIDED IN CONNECTION WITH NATIONAL SEMICONDUCTOR CORPORATION ("NATIONAL") PRODUCTS. NATIONAL MAKES NO REPRESENTATIONS OR WARRANTIES WITH RESPECT TO THE ACCURACY OR COMPLETENESS OF THE CONTENTS OF THIS PUBLICATION AND RESERVES THE RIGHT TO MAKE CHANGES TO SPECIFICATIONS AND PRODUCT DESCRIPTIONS AT ANY TIME WITHOUT NOTICE. NO LICENSE, WHETHER EXPRESS, IMPLIED, ARISING BY ESTOPPEL OR OTHERWISE, TO ANY INTELLECTUAL PROPERTY RIGHTS IS GRANTED BY THIS DOCUMENT.

TESTING AND OTHER QUALITY CONTROLS ARE USED TO THE EXTENT NATIONAL DEEMS NECESSARY TO SUPPORT NATIONAL'S PRODUCT WARRANTY. EXCEPT WHERE MANDATED BY GOVERNMENT REQUIREMENTS, TESTING OF ALL PARAMETERS OF EACH PRODUCT IS NOT NECESSARILY PERFORMED. NATIONAL ASSUMES NO LIABILITY FOR APPLICATIONS ASSISTANCE OR BUYER PRODUCT DESIGN. BUYERS ARE RESPONSIBLE FOR THEIR PRODUCTS AND APPLICATIONS USING NATIONAL COMPONENTS. PRIOR TO USING OR DISTRIBUTING ANY PRODUCTS THAT INCLUDE NATIONAL COMPONENTS, BUYERS SHOULD PROVIDE ADEQUATE DESIGN, TESTING AND OPERATING SAFEGUARDS.

EXCEPT AS PROVIDED IN NATIONAL'S TERMS AND CONDITIONS OF SALE FOR SUCH PRODUCTS, NATIONAL ASSUMES NO LIABILITY WHATSOEVER, AND NATIONAL DISCLAIMS ANY EXPRESS OR IMPLIED WARRANTY RELATING TO THE SALE AND/OR USE OF NATIONAL PRODUCTS INCLUDING LIABILITY OR WARRANTIES RELATING TO FITNESS FOR A PARTICULAR PURPOSE, MERCHANTABILITY, OR INFRINGEMENT OF ANY PATENT, COPYRIGHT OR OTHER INTELLECTUAL PROPERTY RIGHT.

LIFE SUPPORT POLICY

NATIONAL'S PRODUCTS ARE NOT AUTHORIZED FOR USE AS CRITICAL COMPONENTS IN LIFE SUPPORT DEVICES OR SYSTEMS WITHOUT THE EXPRESS PRIOR WRITTEN APPROVAL OF THE CHIEF EXECUTIVE OFFICER AND GENERAL COUNSEL OF NATIONAL SEMICONDUCTOR CORPORATION. As used herein:

Life support devices or systems are devices which (a) are intended for surgical implant into the body, or (b) support or sustain life and whose failure to perform when properly used in accordance with instructions for use provided in the labeling can be reasonably expected to result in a significant injury to the user. A critical component is any component in a life support device or system whose failure to perform can be reasonably expected to cause the failure of the life support device or system or to affect its safety or effectiveness.

National Semiconductor and the National Semiconductor logo are registered trademarks of National Semiconductor Corporation. All other brand or product names may be trademarks or registered trademarks of their respective holders.

Copyright© 2008 National Semiconductor Corporation

For the most current product information visit us at www.national.com



**National Semiconductor
Americas Technical
Support Center**
Email: support@nsc.com
Tel: 1-800-272-9959

**National Semiconductor Europe
Technical Support Center**
Email: europe.support@nsc.com
German Tel: +49 (0) 180 5010 771
English Tel: +44 (0) 870 850 4288

**National Semiconductor Asia
Pacific Technical Support Center**
Email: ap.support@nsc.com

**National Semiconductor Japan
Technical Support Center**
Email: jpn.feedback@nsc.com